

ASTORIA

Standard Features:

- Advanced unidirectional suspension system
- Premium high-density, high-resiliency foam seats
- Quick-ship delivery
- Lifetime warranty on frame & suspension
- Loose back & seat cushions
- Buttonless tufting seat cushions
- Double needle top stitch using thick thread

Options:

- Wood legs available in Acorn, Espresso or Walnut finish

Please use actual leather, fabric and Ultrasuede® swatches when specifying furniture as the colors shown may vary due to the printing process.

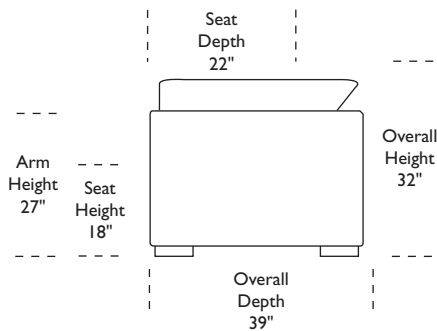
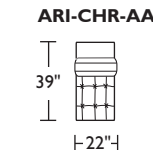
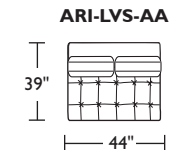
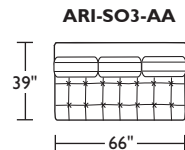
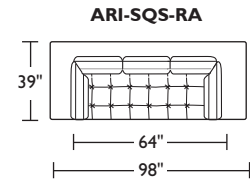
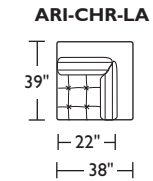
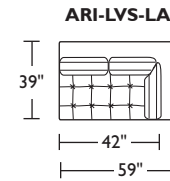
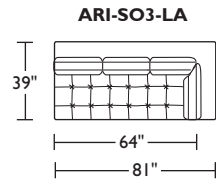
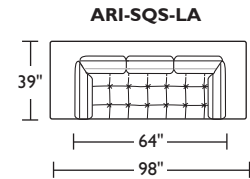
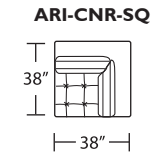
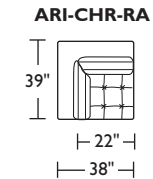
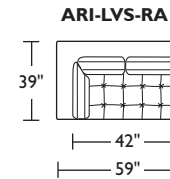
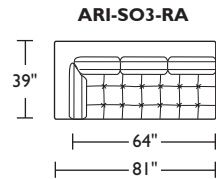
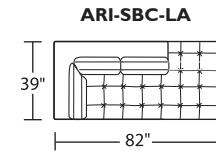
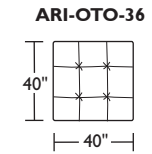
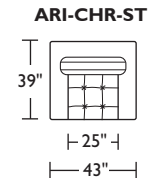
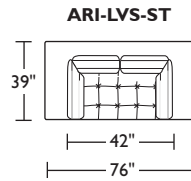
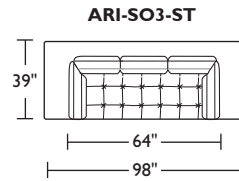
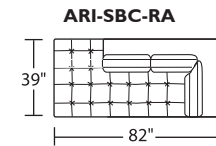
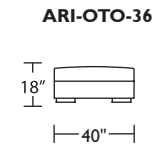
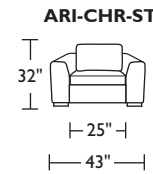
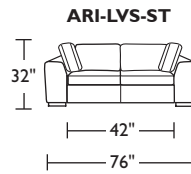
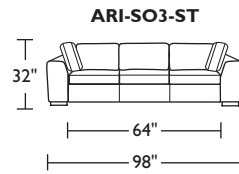

Scale: 1/8 inch = 1 foot
All dimensions are approximate and subject to change.
Specify components from the sitting position.