

RAYNA

Standard Features:

- Advanced unidirectional suspension system
- Premium high-density, high-resiliency foam seats
- Tight channel back and loose seat cushions
- Single-needle top-stitch
- Lifetime warranty on frame and suspension
- Quick-ship delivery
- Stainless steel legs

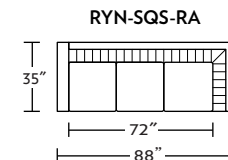
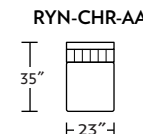
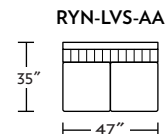
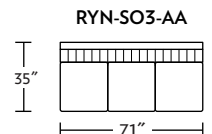
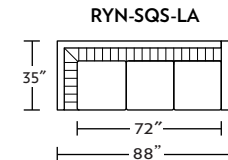
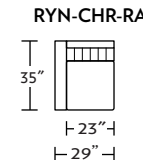
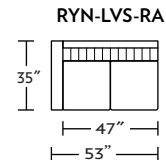
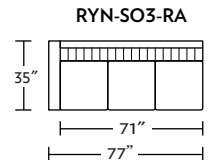
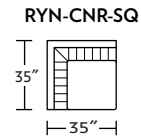
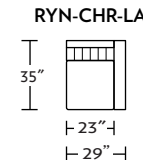
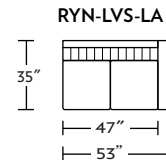
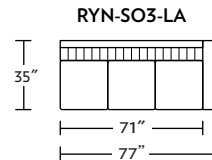
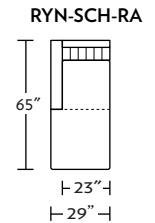
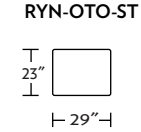
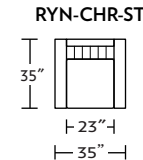
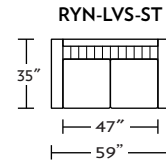
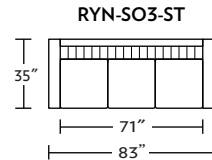
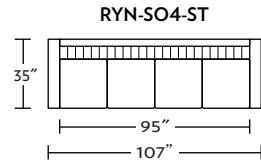
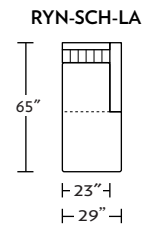
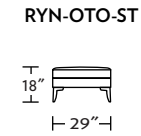
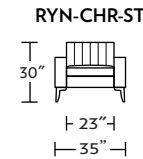
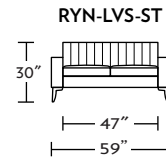
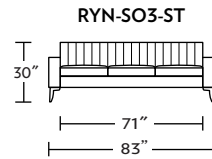
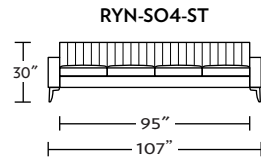

Please use actual leather, fabric, and Ultrasuede® swatches when specifying furniture as the colors shown may vary due to the printing process.

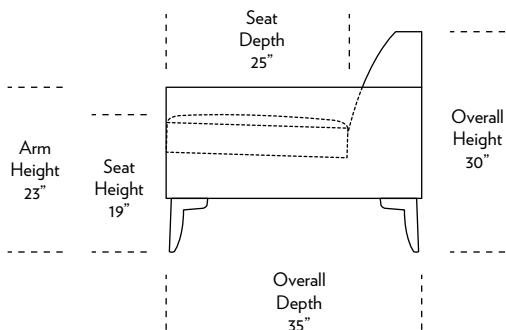

Note: Dotted lines indicate seam on leather and up the roll fabrics. Seams are eliminated with railroaded fabrics.

Scale: 1/8 inch = 1 foot
All dimensions are approximate and subject to change.
Specify components from the sitting position.